

CODE NUMBER

3365451BT

DESCRIPTION

8" Trim Plate, Box Transformer Power Supply, Below Deck
 Thermostatic Mixing Valve, Polished Chrome Finish, 1.5 gpm, Shower
 Head Spray, Infrared Sensor, Smart Faucet, Optima® Hardwired-
 Powered Deck-Mounted Gooseneck Body Faucet.

DETAILS

- Flow Rate: 1.5 gpm (6 Lpm) (1.5GPM)
- Spray Type: Shower Head (SHR)
- Spout Type: Surgical Bend (S)
- Sensor Type: Infrared (IR)
- Mounting Type: Single Hole
- Trim Plate: 8" (203mm) (8)
- Power Supply: Box Transformer (BOX)
- Temperature Mixer: Below Deck Thermostatic Mixing Valve (BDT)
- Finish: Polished Chrome (CP)
- Factory Default Timeout: 30s
- Factory Default GPC: 0.75

FEATURES

Commercial Grade Faucet, ADA Compliant, Cast Brass Spout, Quick
 Connect Fittings, Integrated Water Shut-off, Wireless Settings
 Adjustment, On-demand or Metered activation, Hygienic Line Flush,
 Water Usage and Battery Strength Reporting, Self-adapting Sensor

ELECTRICAL SPECIFICATIONS

- Battery Life: 3 years 8,000 cycles/month
 - Optional power harvesting significantly extends service life.
- Self-Adjustment Range: 0" (0mm)
- Sensor Range: 0" (0mm)
- Timeout Adjustment Settings: 30s

VIDEOS

- ▶ Optima Faucet App
- ▶ Sloan Optima Below Deck Faucet

DOWNLOADS

- [ETF 500/500 S-H/700/700 S-H Installation Instructions](#)
- [Optima Smart Faucet Below Deck Installation Instructions](#)
- [Trim Plates Repair and Maintenance Guide](#)
- [Faucet Spray Heads Repair and Maintenance Guide](#)
- [Optima ETF 700 Repair and Maintenance Guide](#)
- [ETF-700/700-S and EBF-750/750-S Below Deck Repair and Maintenance Guide](#)
- [Additional Downloads](#)

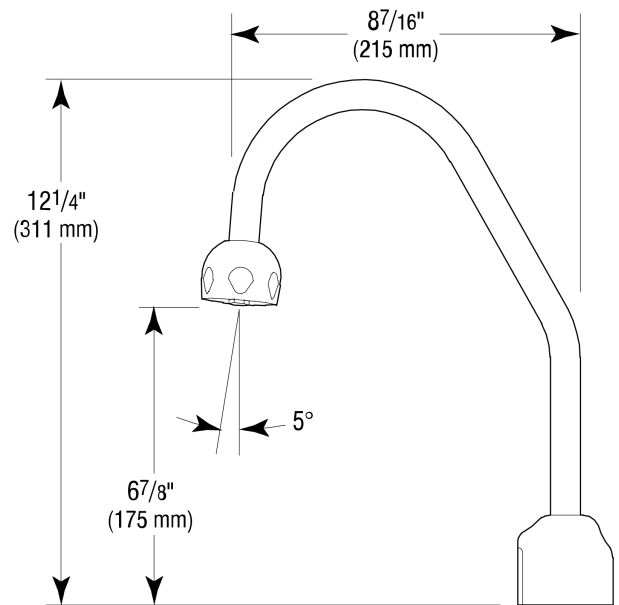

COMPLIANCES & CERTIFICATIONS

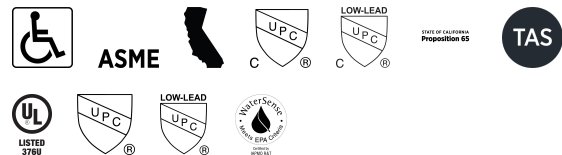

(ADA Compliant, ASME A112.18.1 Compliant, CEC Compliant, cUPC Certified, cUPC Low Lead Compliant, Proposition 65, TAS, UL Certified, UPC Certified, UPC Low Lead Compliant, WaterSense Listed)

RECOMMENDED SPECIFICATION

Faucet shall include cast brass body, quick-connect fittings, twist-off/shut-off solenoid assembly, removable battery cartridge, flexible power supply and allow adjustment of settings wirelessly via Apple or Android smartphones.

NOTES

All information contained within this document subject to

change without notice.

Looking for other variations of the ETF-700 product? [View the general spec sheet with all options.](#)

[Find a matching soap dispenser](#) for this faucet.

[Find a compatible sink](#) for this faucet.

WARRANTY

3 Year

ROUGH-IN

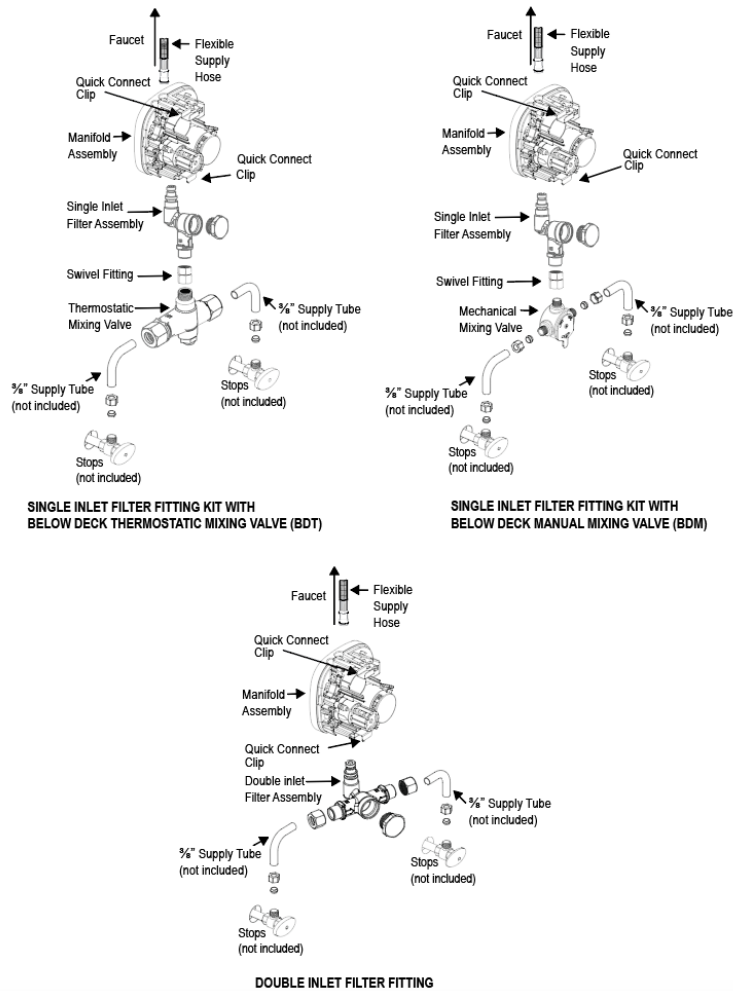

Sloan 10500 Seymour Ave, Franklin Park, IL 60131

Phone: 800.982.5839 • Fax: 800.447.8329 • sloan.com