

**CODE NUMBER**

3365266BT

**DESCRIPTION**

4" Trim Plate, Plug Adapter Power Supply, Below Deck Thermostatic Mixing Valve, Polished Chrome Finish, 0.5 gpm, Multi-Laminar Spray, Infrared Sensor, Smart Faucet, Optima® Hardwired-Powered Deck-Mounted Low Body Faucet.

**DETAILS**

- Flow Rate: 0.5 gpm (2 Lpm) (0.5GPM)
- Spray Type: Multi-Laminar (MLM)
- Sensor Type: Infrared (IR)
- Mounting Type: Single Hole
- Trim Plate: 4" (102mm) (4)
- Power Supply: Plug Adapter (PLG)
- Temperature Mixer: Below Deck Thermostatic Mixing Valve (BDT)
- Finish: Polished Chrome (CP)
- Factory Default Timeout: 30s
- Factory Default GPC: 0.25

**FEATURES**

Commercial Grade Faucet, ADA Compliant, Cast Brass Spout, Quick Connect Fittings, Integrated Water Shut-off, Wireless Settings Adjustment, On-demand or Metered activation, Hygienic Line Flush, Water Usage and Battery Strength Reporting, Self-adapting Sensor

**ELECTRICAL SPECIFICATIONS**

- Battery Life: 3 years 8,000 cycles/month
  - Optional power harvesting significantly extends service life.
- Self-Adjustment Range: 0" (0mm)
- Sensor Range: 0" (0mm)
- Timeout Adjustment Settings: 30s

**VIDEOS**

- ▶ Optima Faucet App
- ▶ Sloan Optima Below Deck Faucet

**DOWNLOADS**

- [ETF 600/610 Installation Instructions](#)
- [Optima Smart Faucet Below Deck Installation Instructions](#)
- [Trim Plates Repair and Maintenance Guide](#)
- [Faucet Spray Heads Repair and Maintenance Guide](#)
- [Optima ETF 600/610 Repair and Maintenance Guide](#)
- [ETF-610/EBF-615 Below Deck Repair and Maintenance Guide](#)
- [Additional Downloads](#)



Variation not shown: 4" Trim Plate

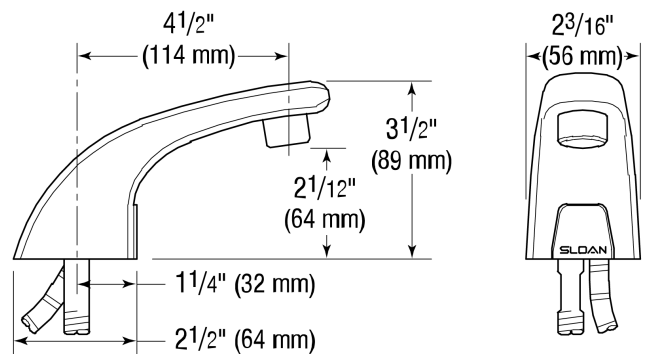

**COMPLIANCES & CERTIFICATIONS**



(ADA Compliant, ASME A112.18.1 Compliant, CalGreen Compliant, CEC Compliant, cUPC Certified, cUPC Low Lead Compliant, GPC 0.25 or less, NYC604.4, Proposition 65, TAS, UL Certified, UPC Certified, UPC Low Lead Compliant)

**RECOMMENDED SPECIFICATION**

Faucet shall include cast brass body, quick-connect fittings, twist-off/shut-off solenoid assembly, removable battery cartridge, flexible power supply and allow adjustment of settings wirelessly via Apple or Android smartphones.

**NOTES**

All information contained within this document subject to change without notice.

Looking for other variations of the ETF-610 product? [View the general spec sheet with all options.](#)

[Find a matching soap dispenser](#) for this faucet.

[Find a compatible sink](#) for this faucet.

**Sloan 10500 Seymour Ave, Franklin Park, IL 60131**

Phone: 800.982.5839 • Fax: 800.447.8329 • [sloan.com](http://sloan.com)

**WARRANTY**

3 Year

**ROUGH-IN**



**Sloan 10500 Seymour Ave, Franklin Park, IL 60131**  
 Phone: 800.982.5839 • Fax: 800.447.8329 • [sloan.com](http://sloan.com)